

INSTALLATION INSTRUCTIONS

CRL SECURITY SCREEN SLIMLINE SLIDING DOOR



Phone: (800) 421-6144 • Fax: (866) 921-0531
crlaurence.com • usalum.com • crl-arch.com

MODEL IDENTIFICATION

Inside Mount

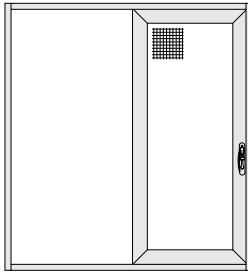

GD11_

Slimline Single Sliding Screen on Single Track

Surface Mount

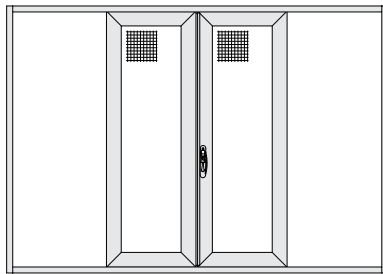
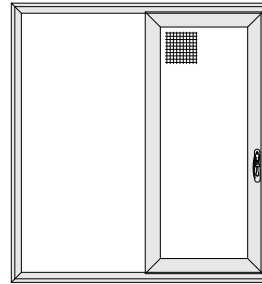

GD12_

Slimline Double Sliding Screen on Single Track

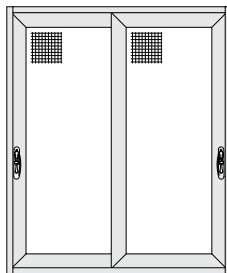
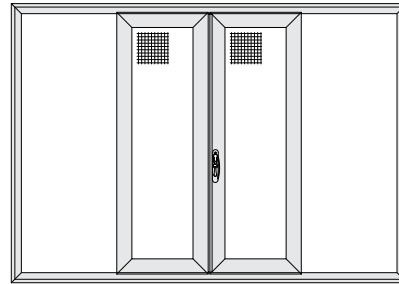

GD22_

Slimline Double Sliding Screen on Double Track

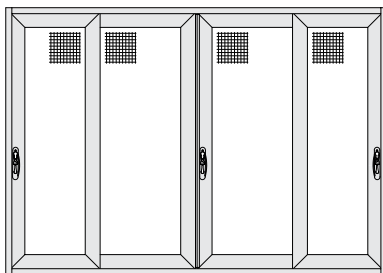
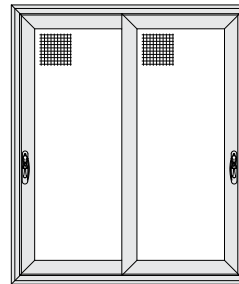

GD24_

Slimline Four Sliding Screens on Double Track

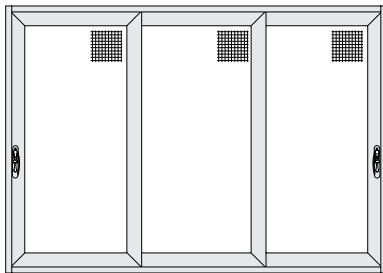
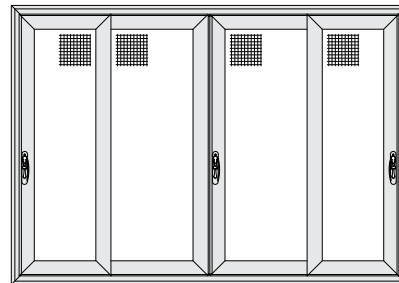

GDS3_

Slimline Triple Sliding Screen on Triple Track

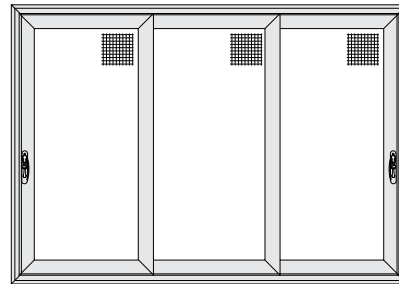

INTRODUCTION

All CRL Security Screen Slimline Sliding Doors are fabricated specifically for each order and shipped fully assembled with the screen doors inside the frame. The mounting option, inside or surface mount, along with the door and track configuration, is determined at time of initial order.

The frame is installed with the doors inside. This manual includes instructions for both inside mount and surface mount. Carefully follow the procedures specific to your installation.

Larger units may be shipped in two sections. Refer to Oversized Frame Installation for splicing information.

When a single door on a single track is installed the screen door is attached to the fixed glass door to prevent the screen door from being removed from the exterior. See Single Door Installation for additional instructions.

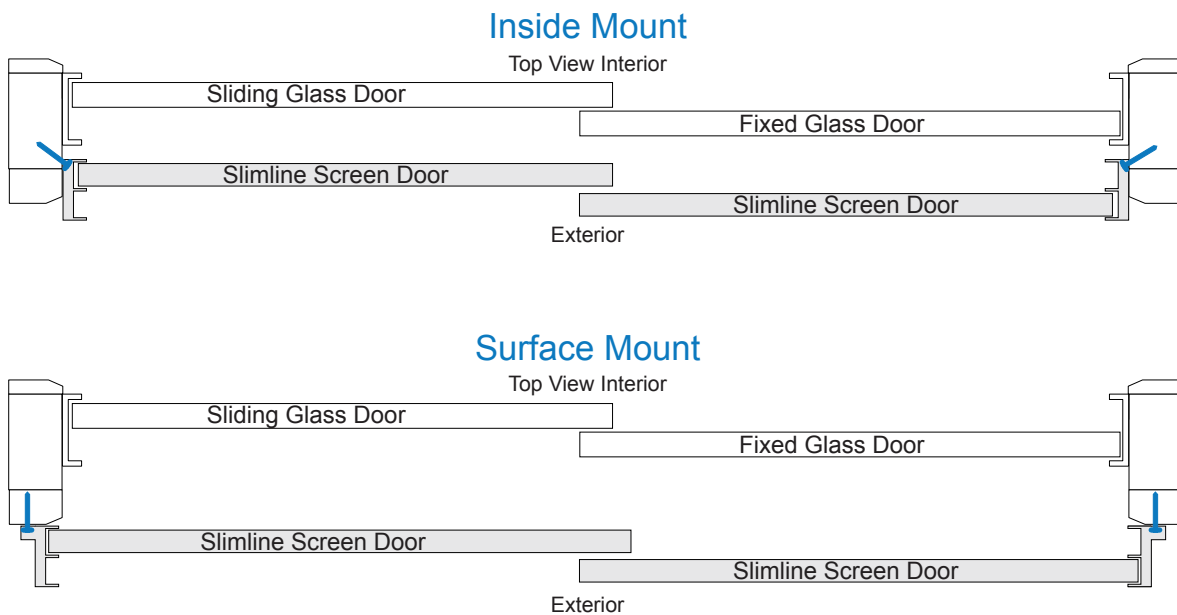

RECOMMENDED FASTENERS

T20 Bronze Star Exterior Coated Screws are recommended for all CRL Security Screen installations.

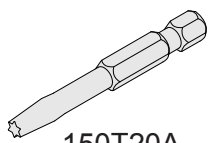

150T20A
1/4" Hex T20 Torx®
Insert Bit - 2" Long

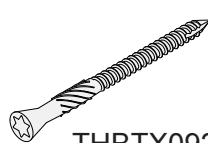

THBTX09200
#9 x 2" (51 mm) T20 Bronze Star
Trim Head Star Drive Screws



THBTX09300
#9 x 3" (76 mm) T20 Bronze Star
Trim Head Star Drive Screws

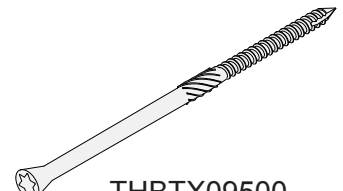

THBTX09500
#9 x 5" (127 mm) T20 Bronze Star
Trim Head Star Drive Screws

NOTE: Model GD22_ Slimline Double Sliding Screen on Double Track shown in installation examples.

ORDER OF ASSEMBLY AND INSTALLATION

Model Identification	2
Introduction	3
Recommended Fasteners	3
Inside Mount Preparation	4
Inside Mount Installation	5 - 6
Surface Mount Installation	7
Finishing Angle Installation	8
Oversized Frame Installation	9

IMPORTANT: READ THIS MANUAL THOROUGHLY BEFORE BEGINNING INSTALLATION

INSIDE MOUNT PREPARATION

① Remove Screen Doors from frame and put aside.

② Remove Bottom Tracks.

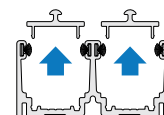
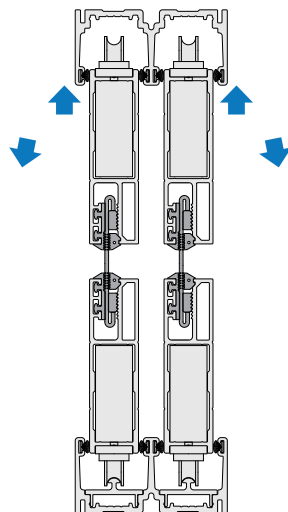
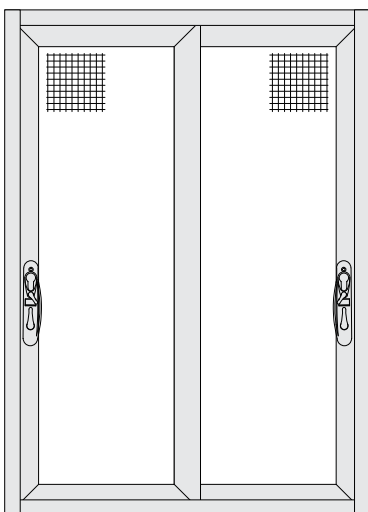

INSIDE MOUNT INSTALLATION

- ① Center frame in opening. Square and plumb.

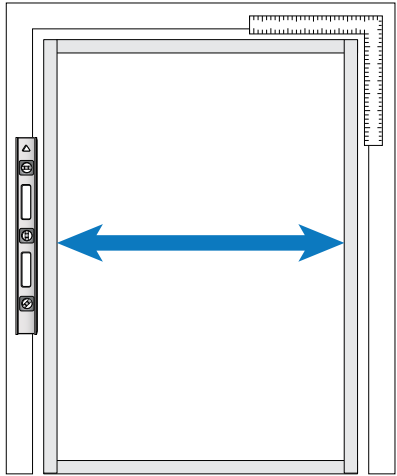

- ② Drill holes and insert screws 3" (76 mm) from corners and 10" to 12" (254 to 305 mm) apart at sides of frame

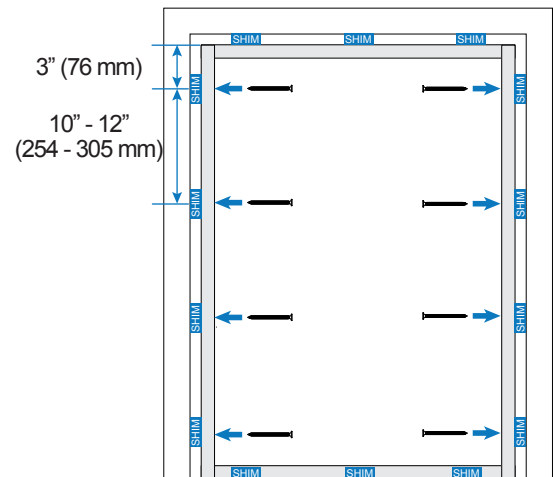
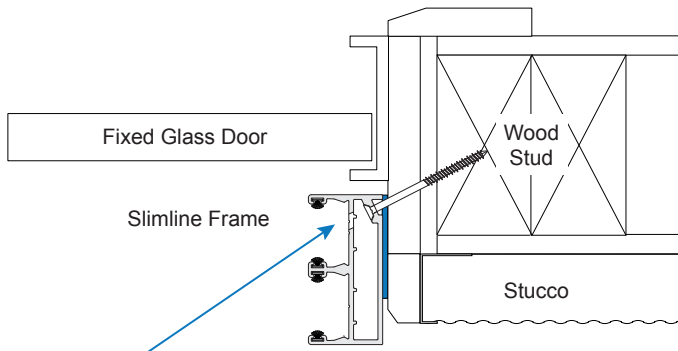

Drill 3/8" (10 mm) clearance hole through first web, and 3/16" (5 mm) hole through second web. Position screws at an angle towards inside into wood stud.

- ③ Drill 3/16" (5 mm) holes and insert screws in top and bottom frame. Stagger screws and anchors appropriate to substrate.

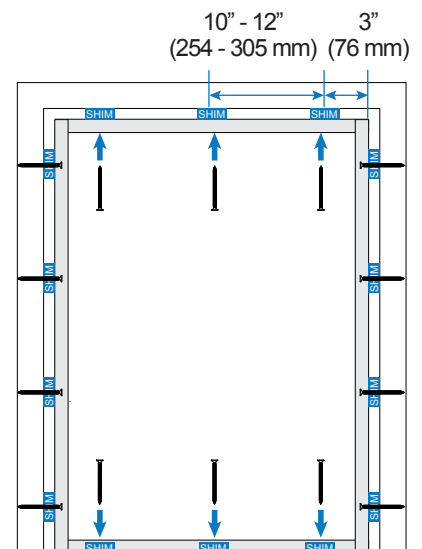
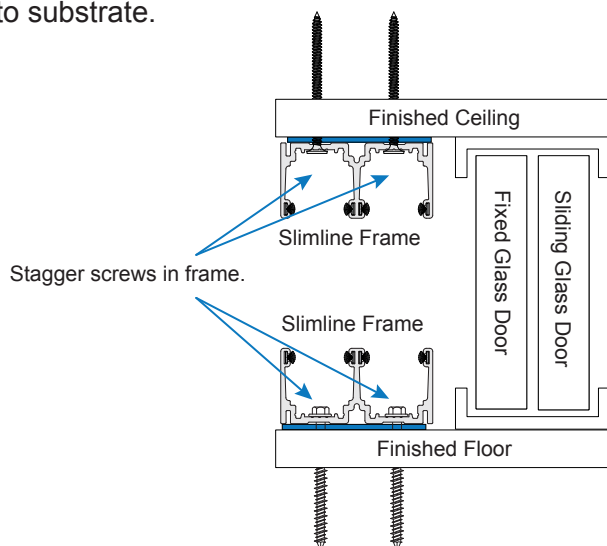

INSIDE MOUNT INSTALLATION (CONTINUED)

- ④ Snap Bottom Track into each channel of bottom frame.

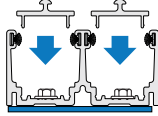

NOTE: Bottom Tracks run length of frame.

- ⑤ Lift and lower first door onto Bottom Track.

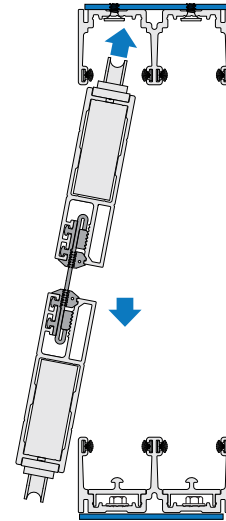

- ⑥ Place longer Top Track into frame above door. Slide to end and snap into place.

NOTE: Each Top Track is split into two uneven pieces.

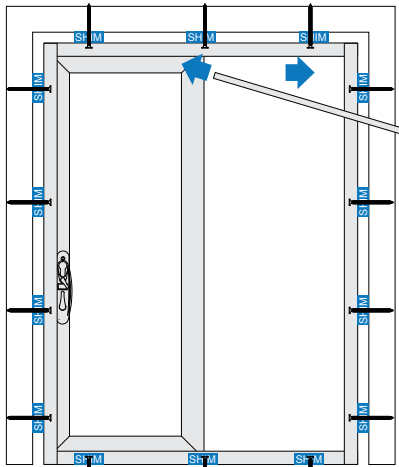

- ⑦ Move door to install shorter Top Track.

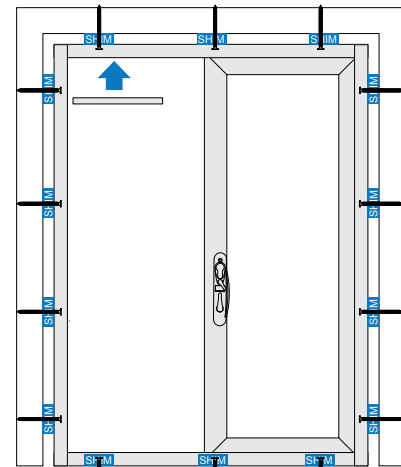

- ⑧ Repeat Steps 6-7 to install second door with longer track on opposite end. Check door operation.

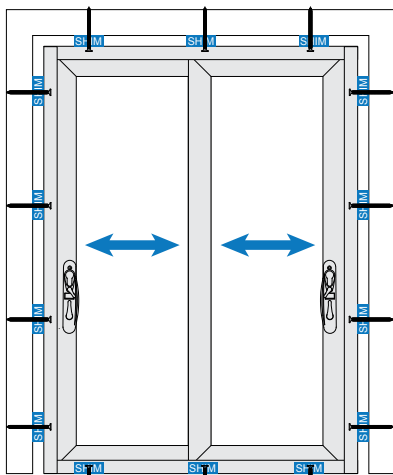

- ⑨ Snap Screw Covers into sides of frame. NOTE: Screw Covers are shipped loose. Trim to fit and snap into place.

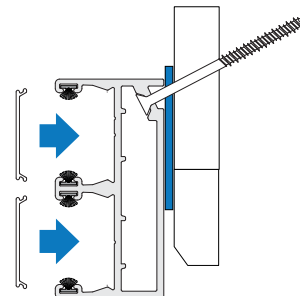

SURFACE MOUNT INSTALLATION

NOTE: Space screws
3" (76 mm) from corners.

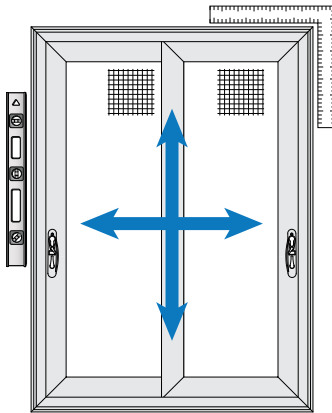

① Center frame with screen doors over opening. Square and plumb.

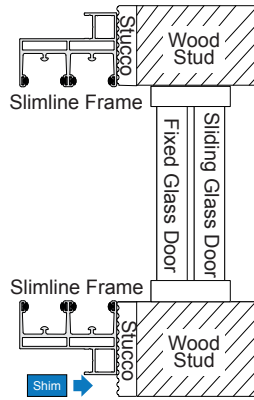

② Temporarily shim at bottom to maintain gap.

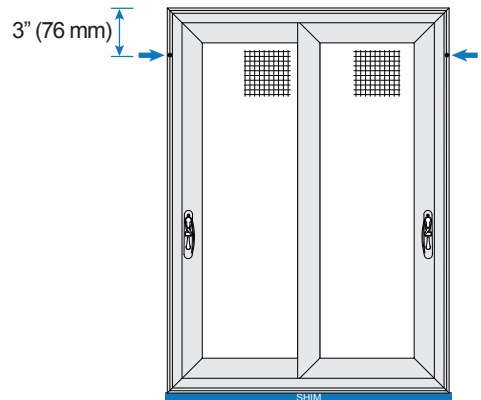

③ Drill pilot holes and insert screws at top corners.

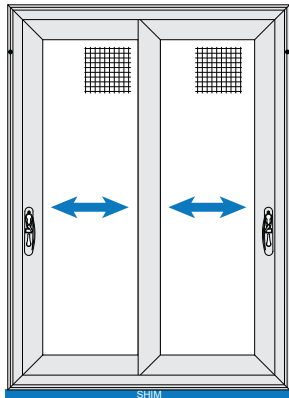

④ Make sure screen doors open smoothly.

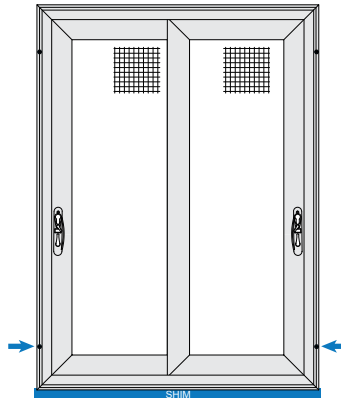

⑤ Drill pilot holes and insert screws at bottom corners.

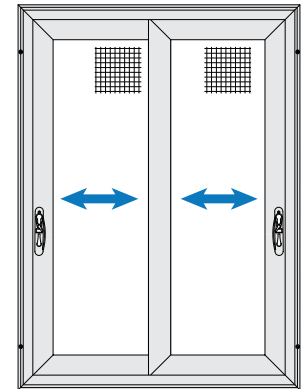

⑥ Check door operation. Remove temporary shim.

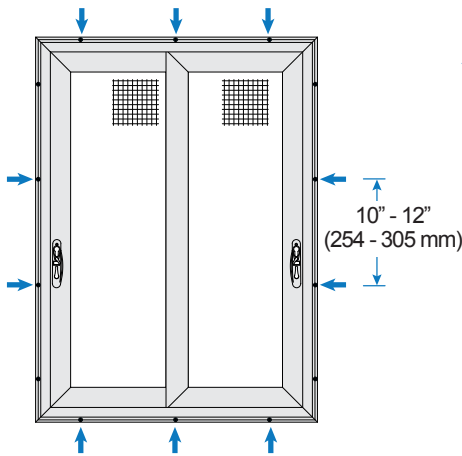

⑦ Space remaining screws 10" to 12" (254 to 305 mm) apart and 3" (76 mm) from corners.

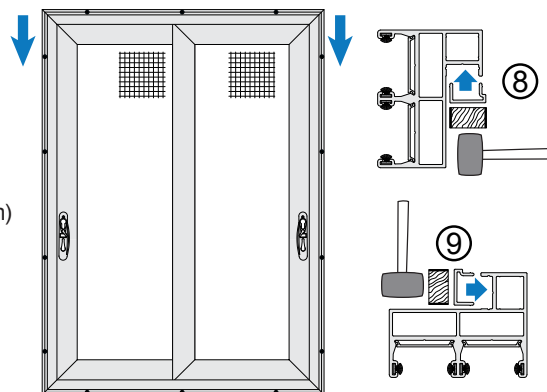

⑧ Tap Vertical Face Cap with rubber mallet and wood block to install. Begin at top corners and work down.

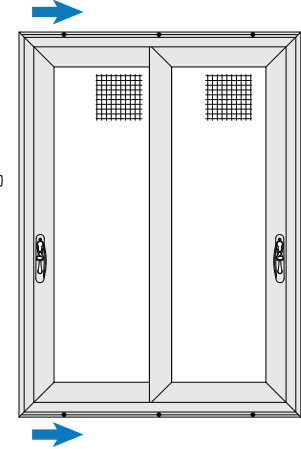

⑨ Repeat with Horizontal Face Caps.

FINISHING ANGLE INSTALLATION

(REQUIRED FOR ALL SINGLE DOORS)

- ① Follow instructions on Pages 4 - 7 to install frame with screen door.
- ② Measure height of Fixed Glass Door between tracks and deduct 1/4" (6 mm).
- ③ Cut Finishing Angle to that length and drill pilot holes every 10" to 12" (254 to 305 mm) and 6" (152 mm) from each end.

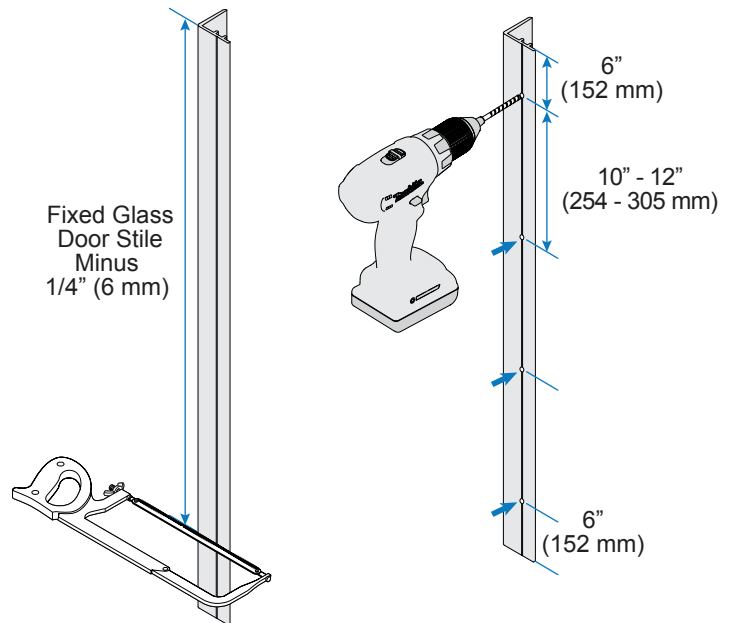
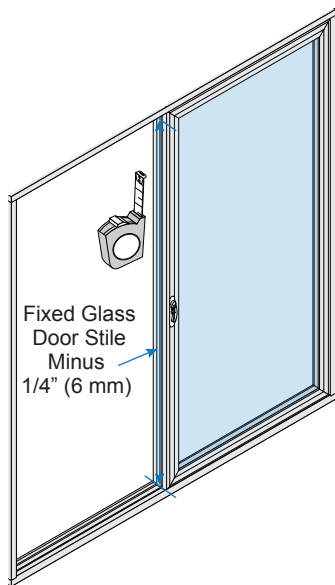

- ④ Center Finishing Angle on fixed glass door stile and match drill pilot holes. Do not drill through glass.

- ⑤ Install Finishing Angle and check to make sure screen door interlocks in the closed position.

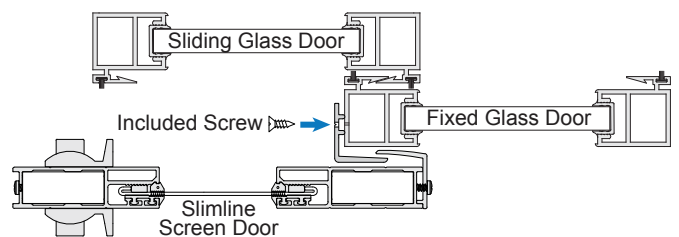
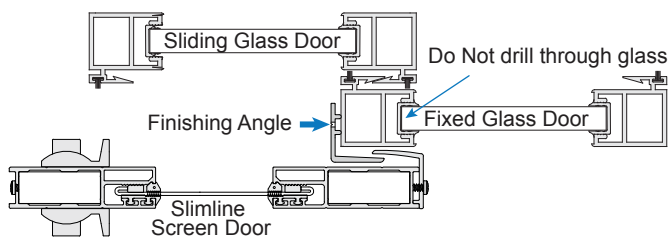

NOTE: Surface Mount Single Sliding Door Installations often require a longer Finishing Angle. Follow the procedure above to install.

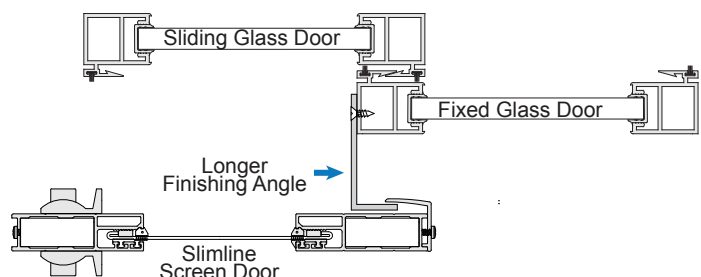

OVERSIZED FRAME INSTALLATION

① Fit Slimline screen doors together.

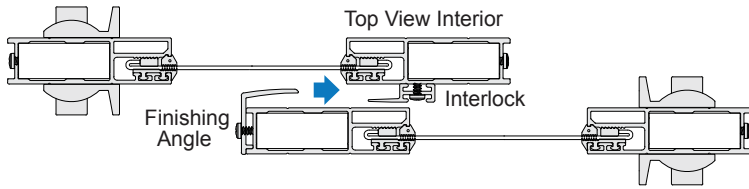

② Align Roller Tracks with Rollers at top and bottom of screen doors.

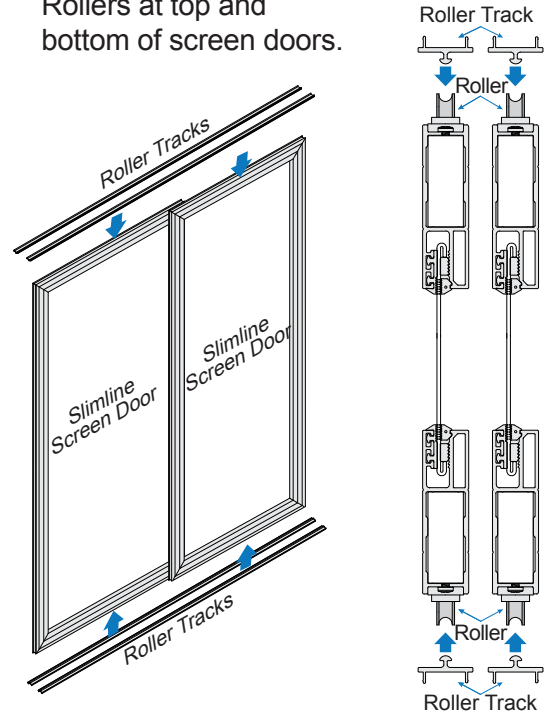

③ Slide halves of frame together making sure Roller Tracks fit into top and bottom frame. Match holes in Roller Tracks with holes in frame and secure with included screws.

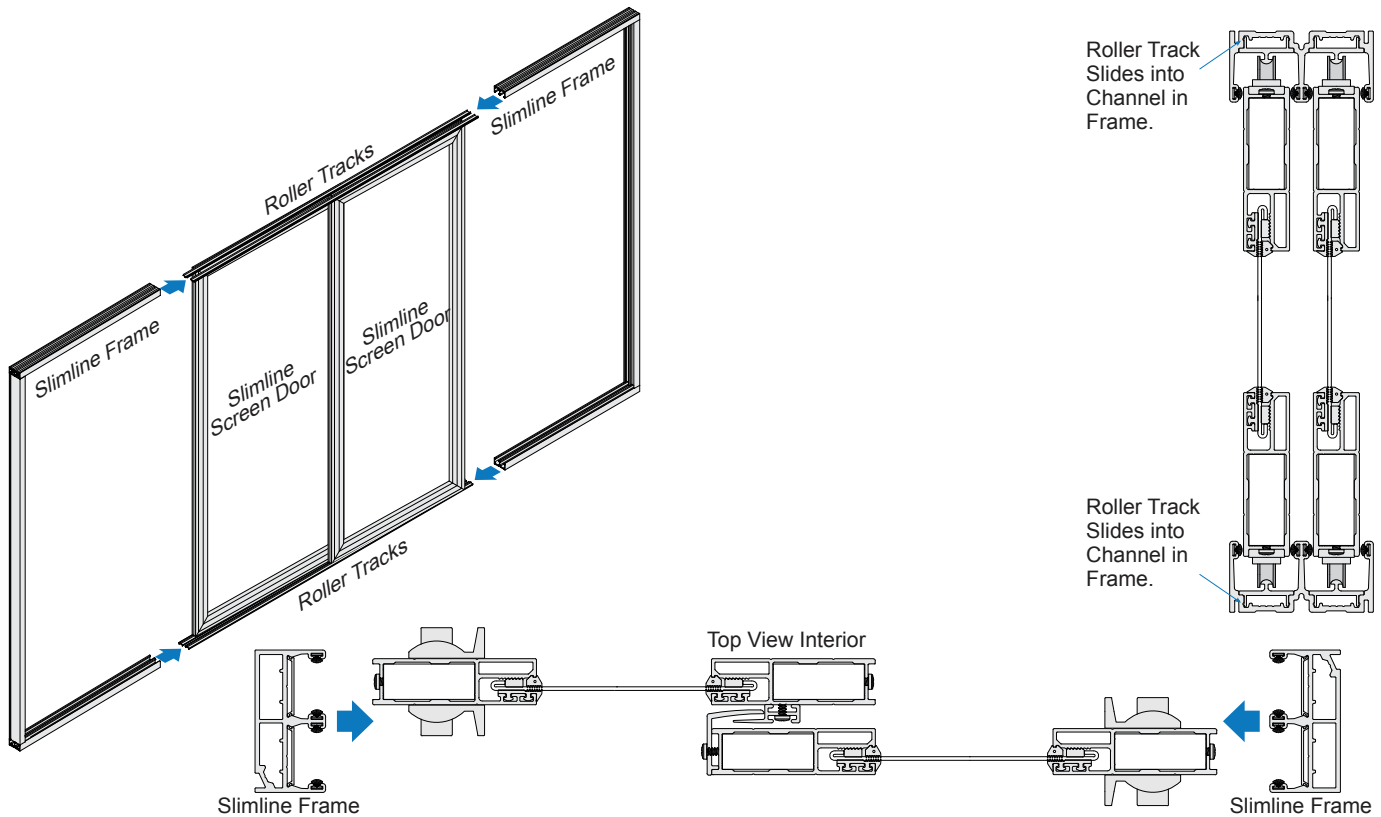

④ Follow instructions on Pages 4 - 7 to install assembled frame with screen doors.

NOTE: Models GD22_ Slimline Double Sliding Screen on Double Track Inside Mount shown.